

A DTA APPARATUS FOR VAPOUR-DEPOSITED SAMPLES. CHARACTERISATION OF SOME VAPOUR-DEPOSITED HYDROCARBONS *

KIYOSHI TAKEDA, MASAHARU OGUNI ** AND HIROSHI SUGA

Department of Chemistry and Microcalorimetry Research Centre, Faculty of Science, Osaka University, Toyonaka, Osaka 560 (Japan)

(Received 11 September 1989)

ABSTRACT

A new differential thermal analysis (DTA) apparatus for vapour-deposited samples has been developed. The apparatus has made it possible to perform vapour-deposition at liquid helium temperatures, and is designed to have high sensitivity for detecting small thermal anomalies by using eight pairs of thermocouples. Vapour-deposited samples of some aliphatic hydrocarbons were characterised in situ by this experiment. The glass transition of propene, observed at 56.0 K, is in reasonable agreement with the literature value of 55 K. Propane and 1-pentene were found to exhibit glass transitions at 45.5 and 71.7 K, respectively. The transition temperature of the latter agrees well with that of a liquid-quenched sample obtained by a conventional DTA experiment. Vapour depositions of ethane and ethene at 4.2 K did not, unfortunately, produce their non-crystalline states.

INTRODUCTION

The preparation of glasses by conventional fast-cooling of liquid is very difficult, especially when the crystallisation rate of the supercooled liquid is high. Rapid crystallisation is typically observed for molecular liquids composed of simple molecules without specific interactions. For these substances, vapour-deposition techniques [1–4] have been established as a powerful method for producing non-crystalline states by by-passing the undesirable crystallisation process. In a previous paper [5], we have shown that the glass-transition temperature was invariant for the vapour-deposited and liquid-quenched samples of butyronitrile. The only difference between the two non-crystalline aggregates is a much higher configurational enthalpy of the vapour-deposited sample compared to that of the liquid-quenched

* Contribution No. 2 from the Microcalorimetry Research Centre.

** Present address: Department of Chemistry, Faculty of Science, Tokyo Institute of Technology, O-okayama, Meguro-ku, Tokyo 152, Japan.

sample. Enthalpy relaxation was found to occur far below the glass-transition temperature for vapour-deposited samples. This behavior may reflect the difference in the efficiency of extracting thermal energy from their respective disordered states during the cooling processes.

Haida et al. [6] reported a simple DTA apparatus for the thermal characterisation of non-crystalline molecular solids deposited at liquid hydrogen temperatures. Simple systems such as tetrachloromethane and propene were vitrified by them for the first time.

In the present paper, we describe a new DTA apparatus constructed for samples which can be deposited at 4.2 K. The lower deposition temperature is expected to make vitrification of simpler substances feasible. The thermal characterisation of some hydrocarbons with a small number of carbon atoms was achieved using the apparatus. The hydrocarbons are simple in the sense that their intermolecular interactions are dominated by the dispersion force. Such a study will contribute to the understanding of the behaviour of the simplest system, the noble gases, whose corresponding glassy states have, so far, only been investigated using computer-simulation experiments [7].

EXPERIMENTAL

Apparatus

A schematic cross-section of a cryostat is shown in Fig. 1. The cryostat is divided into two portions with different roles. The upper portion, of doubly re-entrant shape, is a Pyrex Dewar used for producing and maintaining cryogenic temperatures. The outer re-entrant space (E) is filled with liquid nitrogen, and the inner space (D) with liquid helium or hydrogen, depending on the desired temperature of vapour deposition of the sample. Temperatures as low as 10 K can be produced by evacuating liquid hydrogen through the outlet tube (B). The glass Dewar has such a complex structure that it may be broken by a rapid temperature variation during introduction of the refrigerant. In order to relax such potential strain, a thin copper plate (H), 0.2 mm in thickness, was used as the bottom of the outer refrigerant vessel and a glass bellows (F) was incorporated at the centre of the Dewar.

The lower portion, (I)–(M), is for sample deposition and measurement. A copper block (I), which is fixed at the bottom of the inner vessel of the Dewar by a Kovar–Pyrex seal, is kept at the temperature of the refrigerant (D). Two cold substrates (J), one each for sample deposition and reference, are attached on the copper block. A thermal shield (K) is mechanically fixed to the copper block. An outer shield (L) is soldered to the bottom of the outer Dewar vessel by another Kovar seal. Both of the shields provide stable conditions for the deposition and subsequent DTA experiment. Figure 2 illustrates the details around the sample plate on an enlarged scale. A pair of

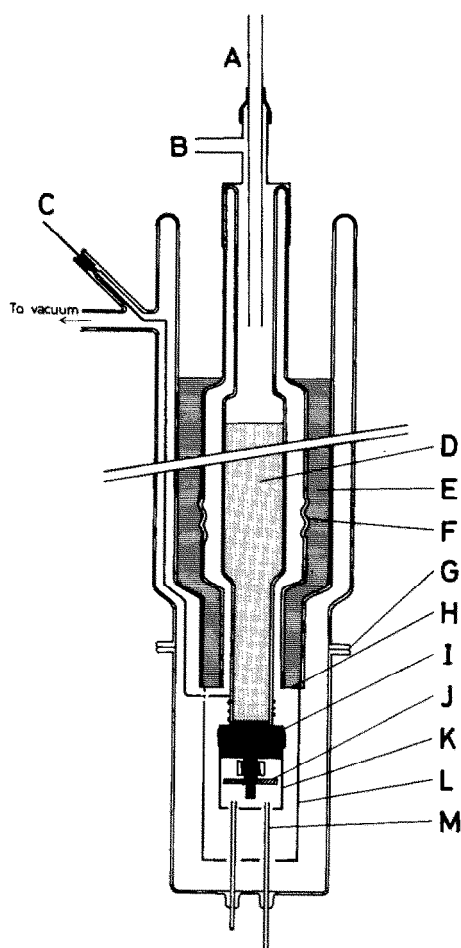

Fig. 1. Schematic cross-section of the cryostat of the DTA apparatus for vapour-deposited samples: A, refrigerant inlet; B, refrigerant outlet; C, electrical wire; D, inner refrigerant vessel; E, outer refrigerant vessel; F, glass bellows; G, ground-glass joint; H, copper plate; I, copper block; J, sample-depositing substrate; K, adiabatic shield; L, radiation shield; M, sample inlet.

$1 \times 1 \text{ cm}^2$ copper substrates, 0.1 mm thick, were fixed symmetrically on both sides of the copper substrate (B) by pressing them with brass pieces (G) and thin mica plates (H) for electrical isolation. One of them is for vapour-deposition and the other is for reference without any deposited material. The sample vapour is introduced through the sample inlet (I) and condensed in vacuo on the substrate (E), which is cooled down in advance to a desired low temperature. The sample inlet is made of copper tube of 2 mm outer diameter and its tip is around 1 cm away from the substrate. The entire inner space is evaporated to around 0.1 mPa by an oil-diffusion pump.

The absolute temperature of the reference plate is monitored by a Chromel-P-(Au + 0.07%Fe) thermocouple in conjunction with a digital mul-

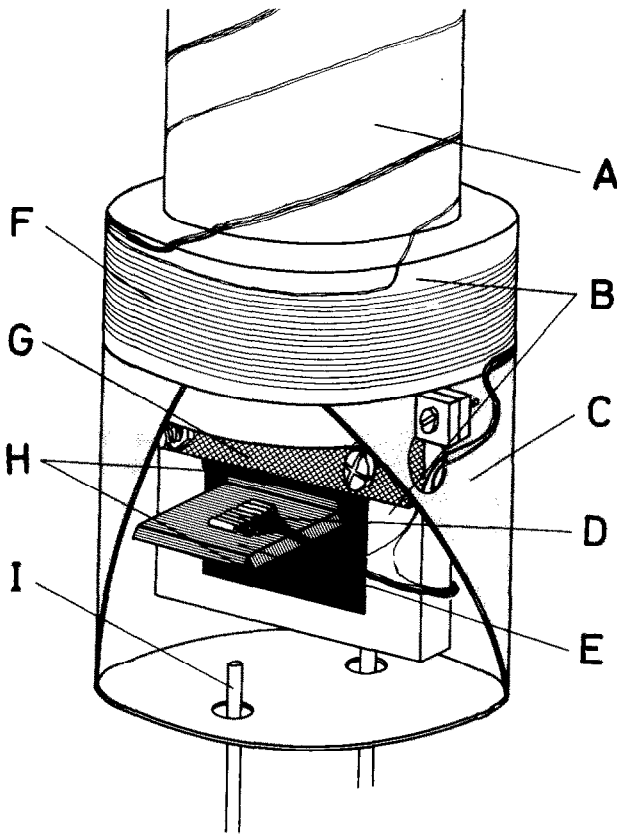

Fig. 2. Magnified sketch around the measurement area: A, inner refrigerant vessel; B, copper block; C, adiabatic shield; D, thermopile and thermocouple; E, sample-depositing substrate; F, heater wire; G, brass fixer; H, mica plate; I, sample inlet.

timer (model 195 from Keithley Instruments, Inc.). Its thermoelectromotive force (EMF) was calibrated at five fixed points against the ice point installed outside the cryostat; the normal melting point of ice, the boiling points of helium and hydrogen, and the triple points of hydrogen and nitrogen. These data were used to correct the EMF table previously reported by the NBS [8]. Eight pairs of Chromel-P-(Au + 0.07%Fe) thermocouples arranged in series are fixed onto the reference and sample substrates in order to detect sensitively the temperature differences between them. The thermocouple signals are amplified with a microvolt meter (model AM-1001 from Ohkura Electric Co., Ltd.) and recorded on a strip chart.

The rate of vapour deposition is controlled with a microvalve installed by the sample inlet, in such a way as to keep the temperature difference between the sample and reference substrates between 0.01 K and 0.05 K, which corresponds to 2–10 μV in EMF. The volume of sample deposited over a few hours is 0.001–0.01 cm^3 . After the deposition, the refrigerant

remaining in the inner Dewar vessel (D in Fig. 1) is evaporated by a heater wound around the copper block (F in Fig. 2) and the DTA experiment is started.

Samples

Ethene, ethane, propene, propane (from Gasukuro Kogyo Inc., > 99.5%) and 1-pentene (from Tokyo Kasei Kogyo Co. Ltd., > 99.8%) were obtained commercially. The four former substances were used, after degassing, without further purification. 1-Pentene was purified by fractional distillation under reduced pressure. Each sample for deposition was stored in a glass container (nearly 150 cm³) equipped with a polytetrafluoroethylene stopcock. The deposition temperatures were 4.2 K for ethene and ethane, 20.4 K for propane and propene, and 63.1 K for 1-pentene.

The DTA experiment was carried out at the heating rate of 1.5–2.5 K min⁻¹ in the range from the temperature of deposition to the temperature at which the sample had completely vaporised. The vapour deposition was performed twice for propane and propene. In the first experiment, the temperature was raised continuously over the whole range to examine the overall thermal anomalies (Run 1). In the second, for which the sample was freshly deposited, the sample was cooled to the lowest temperature from just above or below the temperature at which some anomalies were observed in Run 1, and the next heating experiment was started (Run 2, 3, ...).

For 1-pentene, DTA was also performed with the conventional low-temperature apparatus for the sample of 0.5 cm³ in volume, as previously reported [9].

RESULTS AND DISCUSSION

Ethene and ethane

The upper portion of Fig. 3 shows schematically the DTA signal observed during the vapour deposition of ethene at 4.2 K. The temperature was kept constant and the signal baseline also showed good stability throughout the deposition process. Many spike-like exothermic peaks, however, appeared in the case of this substance. The lower portion of Fig. 3 shows the DTA signal observed in the heating run. No anomaly was observed below 70 K, because above this there is a large endothermic peak due to vaporisation. This leads to the conclusion that the above mentioned peaks occurring during the deposition originated from partial crystallisations. Accumulation of the condensation heat at the deposited surface of the sample is considered to induce quasi-periodical local devitrifications, even at the substrate temperature of 4.2 K.

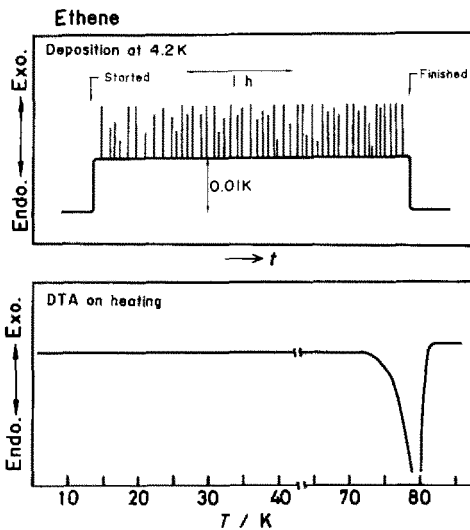

Fig. 3. Schematic DTA signals of ethene detected in the vapour-deposition procedure at 4.2 K (top) and in the heating run (bottom).

The result of a DTA experiment for ethane is reproduced in Fig. 4. Exothermic peaks appear above 23.9 K. These are not, however, due to crystallisation, but to stabilisation between some crystalline modifications, because spike-like peaks similar to those seen for ethene were observed during deposition. It is believed that the sample probably crystallised during condensation. These peaks were not observed in the deposition process for the other substances studied here.

1-Pentene

The results of the DTA experiments for 1-pentene are summarised in Fig. 5. The upper curve was obtained for the liquid-quenched sample using the conventional low-temperature DTA apparatus, and the lower was obtained for the vapour-deposited sample using the present apparatus. The ex-

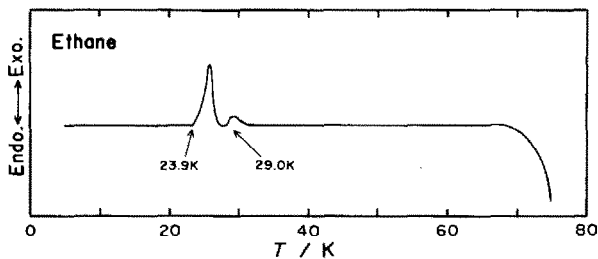

Fig. 4. Schematic DTA signal of vapour-deposited ethane.

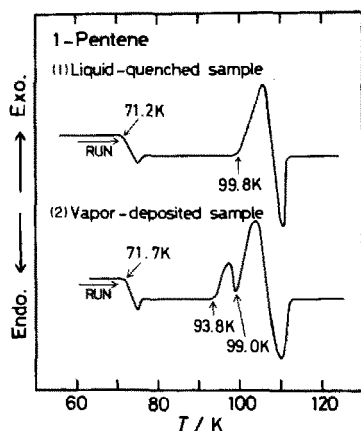

Fig. 5. Schematic results of DTA experiment on glassy 1-pentene. The liquid-quenched sample was measured by a conventional DTA apparatus, and the vapour-deposited sample by the present apparatus.

othermic and subsequent endothermic peaks around 100 K correspond to crystallisation and fusion, respectively. Apparent partition of the crystallisation into two peaks in the vapour-deposited sample is caused by the difference in the homogeneous and heterogeneous nucleation rates in various parts of the sample. The nucleation rate of the sample near the substrate is affected more or less by the nature and quality of the material. Examination of the crystallisation behaviour with different substrates merits further study. Baseline shifts due to the glass transitions were observed at 71.2 K and 71.7 K for the liquid-quenched and vapour-deposited samples, respectively. This is the first time that the glass transition has been observed in this substance. The glass-transition temperatures in the two experiments can be regarded as identical, in view of the differences in the apparatuses used. This provides another example of the fact that the glass transition takes place at essentially the same temperature for the same substance irrespective of the procedure of glass formation.

Propane and propene

DTA curves of vapour-deposited propane are shown in Fig. 6. The glass transition was found at 45.5 K and the crystallisation at 48.7 K. Another exothermic peak at 63.5 K could be due to an irreversible transformation from an unidentified modification to the stable crystalline forms. The endothermic peak at 85.4 K is due to fusion, which agrees with the literature value. The broad exothermic peak at the earlier heating stages of Run 1 may result from an exothermic relaxation phenomenon characteristic of the vapour-deposited glasses [5]. Runs 2, 3 and 4 are the reheating curves obtained after the thermal treatments indicated by the broken lines. The

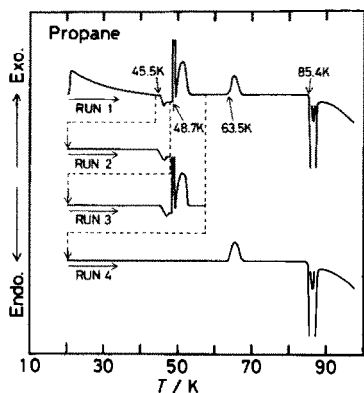

Fig. 6. Schematic DTA curves of vapour-deposited propane. Broken lines represent the thermal history of each sample.

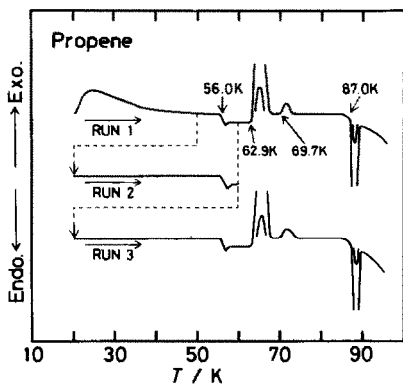

Fig. 7. Schematic DTA curves of vapour-deposited propene. Broken lines represent the thermal history of each sample.

glass transition was observed at the same temperature for the samples that had not experienced crystallisation at 48.7 K (Runs 2 and 3).

Figure 7 shows the results for propene. A broad exothermic effect, indicative of a successful vitrification, is observed just above the vapour-deposition temperature. The glass transition at 56.0 K and crystallisation at 62.9 K can be seen as for propane. The endothermic effect around 87 K is a superposition of the fusion and evaporation. The glass-transition temperature of this substance is roughly in agreement with the 55 K previously reported by Haida et al. [6].

CONCLUDING REMARKS

The newly constructed DTA apparatus is available for the thermal characterisation of in situ vapour-deposited solids at temperatures as low as

4 K. The vapour deposition is much more stable than that previously achieved at liquid hydrogen temperatures [6]. In addition, the use of eight Chromel-P-(Au + 0.07%Fe) thermocouples in series greatly improved the sensitivity in detecting the temperature difference between reference and sample at low temperatures.

The glass transition for propane and 1-pentene at 45.5 K and 71.7 K, respectively, was determined for the first time. Propane and propene are among the simplest compounds so far to have their glassy states established. It was confirmed that the glass-transition temperature of vapour-deposited 1-pentene is identical to that of a liquid-quenched sample, provided their heating rates are similar. The failure to prepare non-crystalline solids of ethene and ethane indicates an inadequate extraction rate for the heat of condensation from the deposited surface to the 4.2 K bath through the non-crystalline sample, which has poor thermal conductivity. Modification of the apparatus to a lower deposition temperature or to a slower deposition rate is an obvious area for further research.

REFERENCES

- 1 D.R. Secrist and J.D. Mackenzie, in J.D. Mackenzie (Ed.), *Modern Aspects of the Vitreous State*, Vol. 3, Chap. 4, Butterworths, London, 1964.
- 2 R. Zallen, *The Physics of Amorphous Solids*, Wiley, New York, 1983.
- 3 J.A. Pryde and G.O. Jones, *Nature*, 170 (1952) 685.
- 4 M. Sugisaki, H. Suga and S. Seki, *Bull. Chem. Soc. Jpn.*, 41 (1976) 2586, 2591.
- 5 H. Hikawa, M. Oguni and H. Suga, *J. Non-Cryst. Solids*, 101 (1988) 90.
- 6 O. Haida, H. Suga and S. Seki, *J. Non-Cryst. Solids*, 22 (1976) 219.
- 7 F. Yonezawa, S. Nosé and S. Sakamoto, *J. Non-Cryst. Solids*, 95/96 (1987) 83.
- 8 L.L. Sparks, R.L. Powell and J. Hall, *Cryogenic Thermocouple Tables*, NBS report 9712, 1968.
- 9 M. Oguni, N. Okamoto, O. Yamamuro, T. Matsuo and H. Suga, *Thermochim. Acta*, 121 (1987) 323.